

8 7 6 5 4 3 2 1

PROPRIETARY AND CONFIDENTIAL
 THE INFORMATION CONTAINED IN THIS DRAWING IS THE SOLE PROPERTY OF
 MILLTRONICS MANUFACTURING. ANY REPRODUCTION IN PART OR AS A WHOLE
 WITHOUT THE WRITTEN PERMISSION OF MILLTRONICS MANUFACTURING IS PROHIBITED.

D

D

C

C

B



B

A

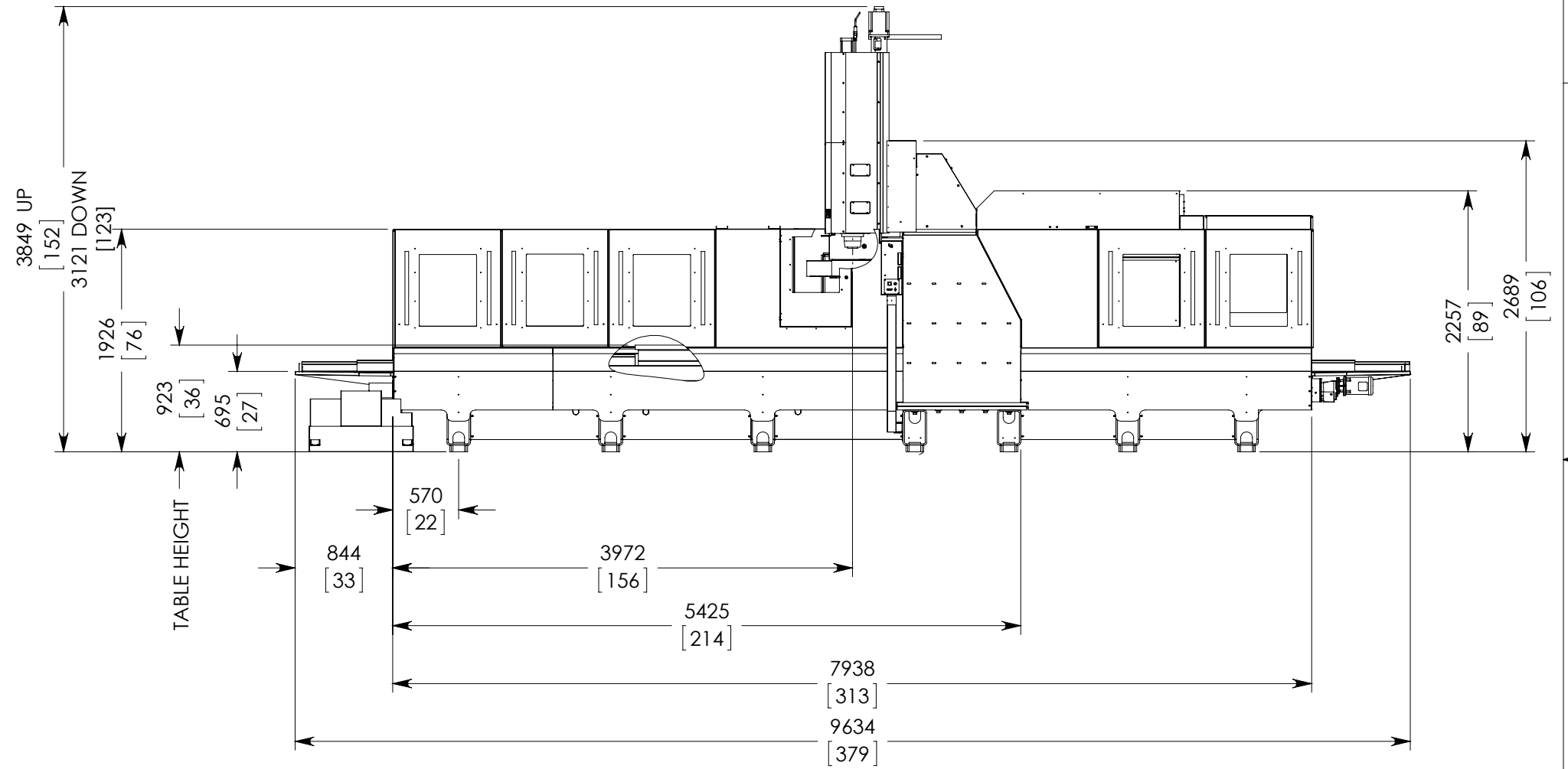
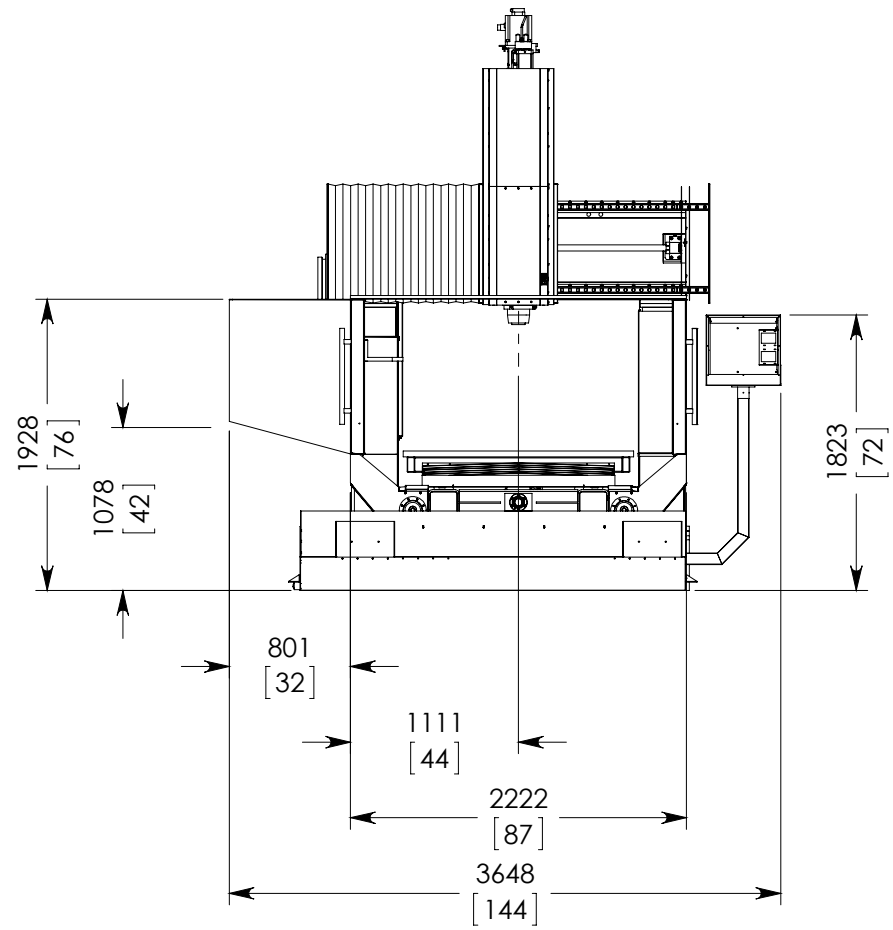
A

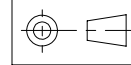

SEE PAGE TWO FOR BASE MOUNTING HOLES

	NAME	DATE	 1400 MILL LANE 952.442.1410 WACONIA, MN 55387 USA
	DRAWN	cfrok13 JUN 13	
MATERIAL:			DRAWING TITLE: BR60-150 FOOTPRINT
FINISH:			
UNLESS OTHERWISE SPECIFIED:			SCALE: 1:50 DRAWING NUMBER: 10031082
DIMENSIONS ARE IN MM [INCHES] TOLERANCES: ANGULAR: MACH ± 1.0 BEND ± NO DECIMAL PLACE ±1 [.039] ONE PLACE DECIMAL ±.5 [.020] TWO PLACE DECIMAL ±.2 [.008] THREE PLACE DECIMAL ±.1 [.004]			
ESTIMATED WEIGHT: 9942.8 Kg.		STOCK/ASSY. NUMBER:	SIZE
		SHEET NUMBER: 1 OF 2	B

8 7 6 5 4 3 2 1

PROPRIETARY AND CONFIDENTIAL
 THE INFORMATION CONTAINED IN THIS DRAWING IS THE SOLE PROPERTY OF
 MILLTRONICS MANUFACTURING. ANY REPRODUCTION IN PART OR AS A WHOLE
 WITHOUT THE WRITTEN PERMISSION OF MILLTRONICS MANUFACTURING IS PROHIBITED.

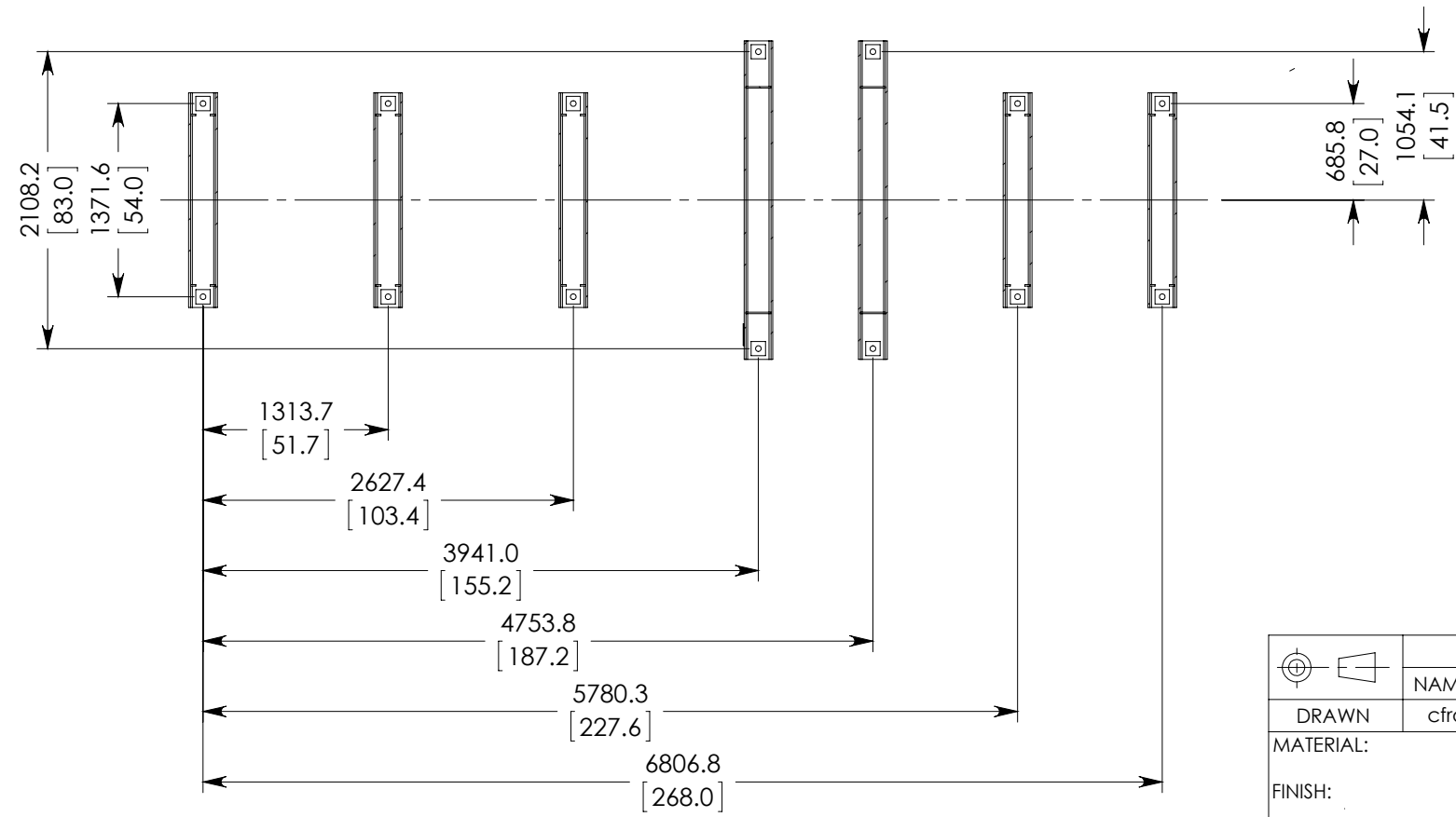
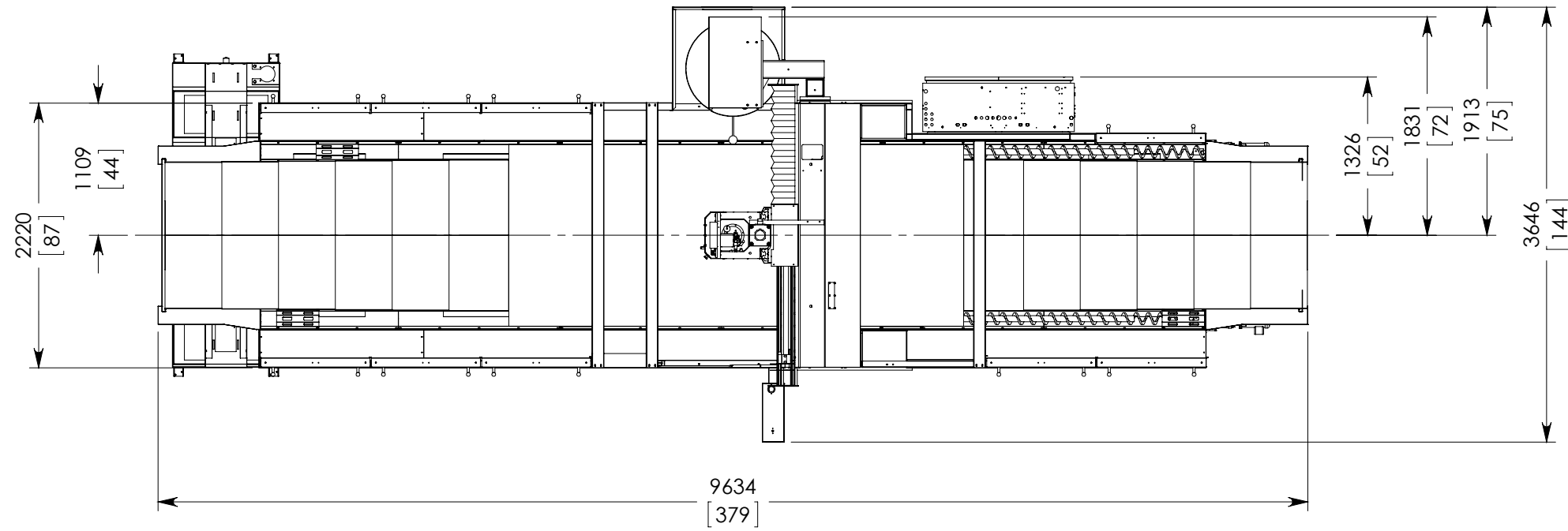

BASE MOUNTING HOLES

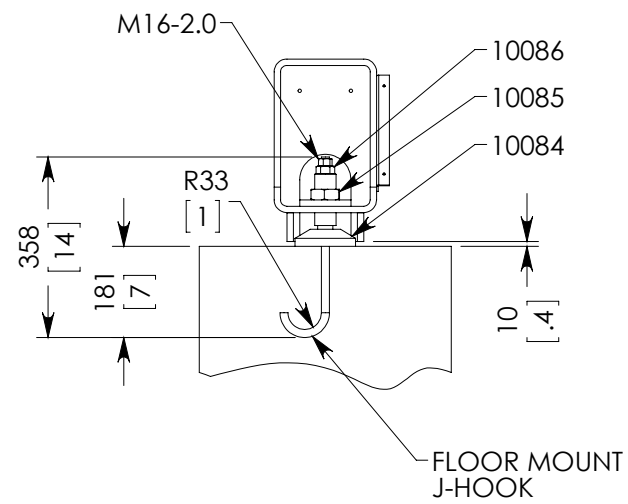

FLOOR MOUNT J-HOOK

	NAME	DATE	 MILLTRONICS C N C MACHINES 1400 MILL LANE 952.442.1410 WACONIA, MN 55387 USA
	DRAWN	cfrok13 JUN 13	
MATERIAL:			DRAWING TITLE:
FINISH:			BR60-150 FOOTPRINT
UNLESS OTHERWISE SPECIFIED:			
DIMENSIONS ARE IN MM [INCHES] TOLERANCES: ANGULAR: MACH ± 1.0 BEND ± NO DECIMAL PLACE ± 1 [.039] ONE PLACE DECIMAL ± .5 [.020] TWO PLACE DECIMAL ± .2 [.008] THREE PLACE DECIMAL ± .1 [.004]			
SCALE: 1:50		DRAWING NUMBER: 10031082	
ESTIMATED WEIGHT: 9942.8 Kg.		STOCK/ASSY. NUMBER:	SIZE
		SHEET NUMBER: 2 OF 2	B